

LIFE SCIENCES

This Test Booklet will contain 145 (20 Part 'A'+50 Part 'B'+75 Part 'C') Multiple Choice Questions (MCQs). Candidates will be required to answer 15 in part 'A', 35 in Part 'B' and 25 questions in Part C respectively (No. of questions to attempt may vary from exam to exam). In case any candidate answers more than 15, 35 and 25 questions in Part A, B and C respectively only first 15, 35 and 25 questions in Parts A, B and C respectively will be evaluated. Questions in Parts 'A' and 'B' carry two marks each and Part 'C' questions carry four marks each. There will be negative marking @25% for each wrong answer. Below each question, four alternatives or responses are given. Only one of these alternatives is the 'CORRECT' answer to the question.

MODEL QUESTION PAPER

PART A

May be viewed under heading "General Science"

PART B

21. Which of the following bonds will be most difficult to break?

1. C–O
2. C–C
3. C–N
4. C–S

22. A solution of 1% (w/v) starch at pH 6.7 is digested by 15 µg of β-amylase (mol wt 152,000). The rate of maltose (mol wt = 342) had a maximal initial velocity of 8.5 mg formed per min. The turnover number is

1. $0.25 \times 10^5 \text{ min}^{-1}$.
2. $25 \times 10^5 \text{ min}^{-1}$.
3. $2.5 \times 10^5 \text{ min}^{-1}$.
4. $2.5 \times 10^4 \text{ min}^{-1}$.

23. The conformation of a nucleotide in DNA is affected by rotation about how many bonds?

1. 4
2. 6
3. 7
4. 3

24. Which of the following proteins acts as an energy transducer?

1. G-protein.
2. Bacteriorhodopsin.
3. Hemoglobin.
4. Heat shock protein.

25. Which of the following predicted property of lipid bilayers would result if the phospholipids had only one hydrocarbon chain instead of two?

1. The bilayers formed would be much less fluid.
2. The diameter of the head group would be much larger than the acyl chain and would tend to form micelles rather than bilayers.
3. the bilayers formed would be much more fluid.
4. the bilayers would be more permeable to small water-soluble molecules.

26. Which pump is responsible for initiating muscle contraction through depolarization of muscle cell membrane?

1. Na^+ pump.
2. K^+ pump.
3. Ca^{2+} pump.
4. Mg^{2+} pump.

27. Which of the following statements is **not** true for transposable element system?

1. It consists of both autonomous and non-autonomous elements.
2. Dissociation elements are autonomous in nature.
3. Transposase is transcribed by the central region of autonomous elements.
4. Certain repeats in the genome remain fixed even after the element transposes out.

28. A set of virulence genes (*vir* genes), located in the *Agrobacterium* Ti-plasmid, is activated by

1. octopine.
2. nopaline.
3. acetosyringone.
4. auxin.

29. When two mutants having the same phenotype were crossed, the progeny obtained showed a wild-type phenotype. Thus the mutations are

1. non-allelic.
2. allelic.
3. segregating from each other.
4. independently assorting.

30. A conjugation experiment is carried out between $F^+ his^+ leu^+ thr^+ pro^+$ bacteria and $F^- his^- leu^- thr^- pro^-$ bacteria for a period of 25 minutes. At this time the mating is stopped, and the genotypes of the recipient F^- bacteria are determined. The results are shown below:

<u>Genotype</u>	<u>Number of colonies</u>
<i>his</i> ⁺	0
<i>leu</i> ⁺	13
<i>thr</i> ⁺	26
<i>pro</i> ⁺	6

What is the probable order of these genes on the bacterial chromosome?

1. *thr, leu, pro, his*
2. *pro, leu, thr* and the position of *his* cannot be determined.
3. *thr, leu, pro*, and the position of *his* cannot be determined.
4. *his, pro, leu, thr*

31. Two varieties of maize averaging 48 and 72 inches in height, respectively, are crossed. The F_1 progeny is quite uniform averaging 60 inches in height. Of the 500 F_2 plants, the shortest 2 are 48 inches and the tallest 2 are 72 inches. What is the probable number of polygenes involved in this trait?

1. Four.
2. Eight.
3. Sixteen.
4. Thirty two.

32. Repair of double strand breaks made during meiosis in the yeast *Saccharomyces cerevisiae*

1. occurs mostly by non-homologous end joining.
2. occurs mostly using the sister chromatid as a template.
3. occurs mostly using the homologous chromosome as a template.
4. is associated with a high frequency of mutations.

33. Which of the following signaling molecules enters the cell to initiate its action?

1. Transferrin
2. Insulin

3. Glucagon
 4. Thyroxine
- 34.** The mode of action of the anticancer drug methotrexate is through its strong competitive inhibition on
1. dihydrofolate reductase.
 2. thymidine synthase.
 3. thymidine kinase.
 4. adenylate cyclase.
- 35.** Which class of immunoglobulins will increase in case of a chronic infection?
1. IgA
 2. IgG
 3. IgM
 4. IgE
- 36.** When prospective neuroectoderm from an early amphibian gastrula is transplanted in the prospective epidermal region of a recipient (early gastrula) embryo, the donor tissue will give rise to
1. neural tube.
 2. epidermis.
 3. neural tube and notochord.
 4. neural tube and epidermis.
- 37.** Amphibian oocytes remain for years in the diplotene stage of meiotic prophase. Resumption of meiosis is initiated by
1. gonadatropic hormone.
 2. growth hormone.
 3. oestrogen.
 4. progesterone.
- 38.** A group of six cells called 'equivalence group cells' divide to form the vulval structure in *Caenorhabditis elegans*. They are called so because
1. they have similar fates during development of vulva.
 2. all the six cells are competent to form vulva and can replace each other under various experimental conditions.
 3. they are all under the influence of the anchor cell, signals from which initiate vulval development.
 4. they interact with each other to form the vulval structure.

- 39.** Due to the presence of cellulose in the cell wall of plants, leaf shape is determined in the leaf primordia by
1. rates of cell division.
 2. planes of cell division.
 3. cell migration.
 4. cell-cell interactions.
- 40.** DCMU inhibits electron transport in chloroplast by preventing the reduction of
1. P 680.
 2. Q_A.
 3. P_Q.
 4. Q_B.
- 41.** In higher plant leaves, the reduction of nitrate to ammonium takes place by the combined action of nitrate reductase localized in cytosol and nitrite reductase localized in
1. peroxisomes.
 2. mitochondria.
 3. chloroplasts.
 4. cytosol.
- 42.** In higher plants, the red/far-red sensory photoreceptor, phytochrome, is a light-regulated kinase. Which of the following classes of kinases does it represent?
1. Two-component sensor regulator (histidine kinase).
 2. Two-component sensor regulator (serine/threonine kinase).
 3. Leucine rich repeat (LRR) receptor kinase.
 4. Calcium-dependent protein kinase.
- 43.** Vesicular-arbuscular mycorrhiza (VAM) represents a beneficial association between plant roots and fungus, where fungus assists plants in obtaining from the soil
1. iron.
 2. zinc.
 3. sulphate.
 4. phosphate.
- 44.** Unidirectional propagation of electrical signal in nervous system is
1. proportional to the length of axon.
 2. due to chemical synapse.
 3. due to electrical synapse.
 4. proportional to myelination.

45. A myasthenia gravis patient develops muscle paralysis because

1. the nerve terminal at the neuromuscular junction fails to release acetylcholine.
2. although enough acetylcholine is released at the neuromuscular junction, it is destroyed by acetylcholinesterase.
3. the patient develops immunity against his own acetylcholine receptor.
4. the patient develops antibody against his own acetylcholine.

46. Inhibin from sertoli cells of testes selectively inhibits

1. luteinizing hormone.
2. follicle stimulating hormone.
3. thyroid stimulating hormone.
4. growth hormone.

47. Hawk's retina possesses a large number of

1. rods.
2. melanocytes.
3. cones.
4. kuffer cells.

48. *E. coli* cells were grown in N^{15} medium for several generations and then shifted to normal medium for one generation. If the DNA isolated from the culture would be centrifuged on a CsCl equilibrium density gradient, the result will be

1. a single band of double helix DNA consisting of one strand with N^{14} and another with N^{15} label.
2. single band of double helix DNA consisting of N^{14} and N^{15} in both the strands.
3. two bands containing double helix DNA each containing both N^{14} and N^{15} label.
4. two bands containing single stranded DNA one with N^{14} and other with N^{15} label.

49. Which of the following processes does not take place in the $5' \rightarrow 3'$ direction?

1. DNA replication
2. Transcription
3. Nick translation
4. RNA editing

50. A deletion of three consecutive bases in the coding region of a gene **cannot** result in

1. deletion of a single amino acid without any other change in the protein.
2. replacement of two adjacent amino acids by a single amino acid.

3. replacement of a single amino acid by another without any other change in sequence of the protein.
 4. production of a truncated protein.
- 51.** Deletion of the leader sequence of *trp* operon of *E. coli* would result in
1. decreased transcription of *trp* operon.
 2. increased transcription of *trp* operon.
 3. no effect on transcription.
 4. decreased transcription of *trp* operon in the presence of tryptophan.
- 52.** In the endodermis of higher plants, the role of Casperian strip is to control the water movement so that it flows
1. between the cells.
 2. through the plasma membrane.
 3. through the cell wall.
 4. through the transfusion tissue.
- 53.** The reptilian order Squamata includes
1. crocodiles and alligators.
 2. the living fossil 'tuatara'.
 3. turtles and tortoises.
 4. snakes and lizards.
- 54.** Cultivated bananas are sterile because
1. male flower-bearing plants are very rare.
 2. they lack natural pollinators in the crop plants.
 3. they are triploid and therefore seeds are not set.
 4. they are a cross of two unrelated species.
- 55.** One life history trait that is **not** characteristic of very small sized organisms is
1. delayed age at first reproduction.
 2. earlier age at first reproduction.
 3. high population growth rate.
 4. short lifespan.
- 56.** Which of the following statements is the most appropriate example of character displacement?
1. Two related species depending on the same prey species avoid competition by feeding at different times of the day.
 2. The body sizes of two related species are very similar when they are allopatric,

but in geographical areas of sympatry, one species is significantly smaller than the other.

3. The food niche of a species is generally wider in the absence of competing species than in their presence.
4. Closely related species can coexist if their densities are regulated by a predator.

57. In a population growing logistically and approaching Carrying Capacity (K), the change in density (N) per unit time (dN/dt) is maximum when N equals to

1. K^2
2. $K/2$.
3. K.
4. K.

58. The losses of ozone over Arctic are significantly lower than that over Antarctica because

1. polar vortex over Arctic is not as tight as over Antarctic.
2. Arctic stratosphere warms slower in the spring.
3. concentration of chlorine in the atmosphere over Arctic is less than over Antarctic.
4. freezing of NO_2 and CH_4 are slower over Arctic than over Antarctic.

59. Which of the following species replacement sequence depicts tolerance model of community succession?

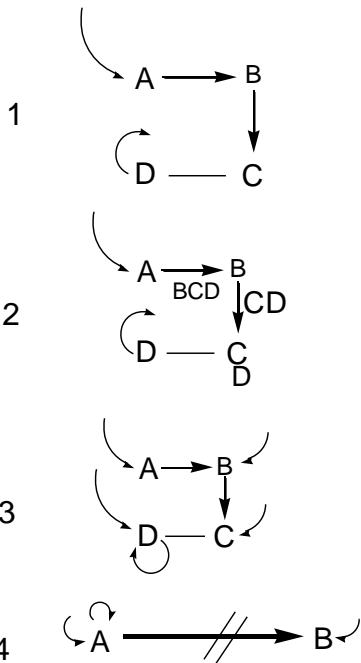

60. Evolutionarily, with which of the following could parental care in animals be associated?

1. Smaller clutch size.
2. Polygamy.
3. Greater longevity.
4. Semelparity.

61.

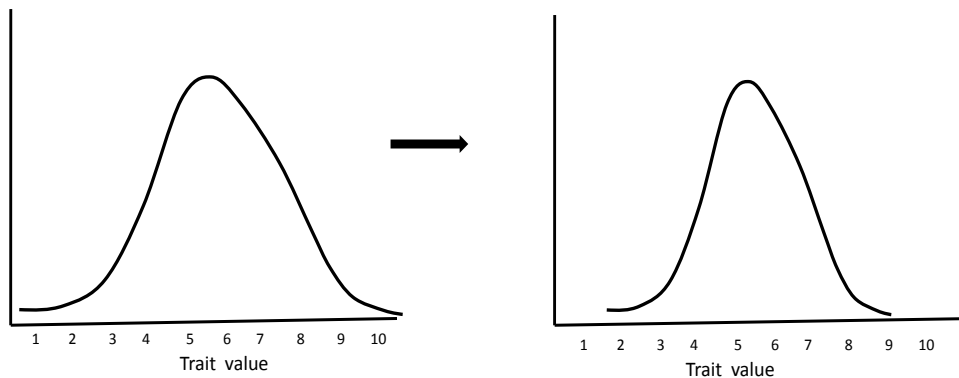

The change in a trait with time as a result of natural selection is shown above. This type of natural selection is

1. directional.
2. disruptive.
3. stabilizing.
4. random.

62. During which geological period did the greatest diversification of life on earth occur?

1. Permian
2. Jurassic
3. Cambrian
4. Ordovician

63. Which of the following plant groups evolved during the Silurian period?

1. Bryophyta
2. Psilophyta
3. Lycophyta
4. Spherrophyta

64. Which of the following GM crops is the most widely cultivated globally?

1. Herbicide resistant soybean.
2. Insect resistant cotton.
3. Insect resistant brinjal.
4. delayed ripening tomato.

65. PCR based DNA amplification is an essential feature of which of the following combination of molecular markers?

1. RFLP, AFLP and SSR.
2. AFLP, SSR and RAPD.
3. RFLP, RAPD and SSR.
4. RAPD, RFLP and SSR.

66. The genes whose promoters are extensively used for production of pharmaceutical proteins in transgenic dairy cattles are

1. lactalbumin and ovalbumin.
2. lactoglobulin and casein.
3. lactoferrin and transferrin.
4. casein and ovalbumin.

67. A biochemist purifies a new enzyme, generating the following purification table.

S. No.	Procedure	Total protein (mg)	Activity (units)
i.	Crude Extract	20,000	4,000,000
ii.	Salt precipitation	5,000	3,000,000
iii.	Ion-exchange chromatography	200	800,000
iv.	Affinity chromatography	50	750,000
v.	Size-exclusion chromatography	45	675,000

The most effective purification step is

1. iv.
2. iii.
3. v.
4. ii.

68. Similarities in sequence and function of two proteins indicate that they are members of a family that share a common ancestor. If they are from different species, they are called

1. homologs.
2. orthologs.
3. paralogs.
4. proteologs.

69. The conformation of a 30-residue peptide is studied by NMR spectroscopy. The J_{NH} for most of the amide protons is 4Hz. The 2D NOESY spectrum shows prominent Ni-Ni⁺¹ connectivities. The conformation of the peptide is
1. anti-parallel β sheet.
 2. parallel β sheet.
 3. helix-like.
 4. unordered.
70. A sample of ³²P disintegrates at a rate of 30,120 dpm. The radioactivity in microcuries (1 curie=3.7x10¹⁰dps) is
1. 15,060.
 2. 1.36x10⁻².
 3. 81.6 x10⁻².
 4. 1.36 x10⁻⁸.

PART C

71. A protein polypeptide chain exists in α -helical conformation in a solvent and it has a value of -30,000 deg cm² dmol⁻¹ for the mean residue ellipticity at 222 nm ($[\theta]_{222}$) in the temperature range 20-50°C. On raising the temperature above 50°C, $[\theta]_{222}$ increases and reaches a value of -2,000 deg cm² dmol⁻¹ at 70°C and the value of $[\theta]_{222}$ remains unchanged above 70°C. The observed value of $[\theta]_{222}$ is -14,000 deg cm² dmol⁻¹ at 60°C. If one assumes that the heat-induced denaturation is a two-state process, the fraction of α -helix at 60°C is
1. 0.40
 2. 0.43
 3. 0.50
 4. 0.57
72. 100 ml of 0.02 M acetic acid ($pK_a = 4.76$) is titrated with 0.02 N KOH. After adding some base to the acid solution, the observed pH is 2.76. At this pH degree of protonation is
1. 0%.
 2. 10%.
 3. 90%.
 4. 99%.
73. There are hydrogen bond donors (D), and acceptors (A). When the mixture (A+D) is transferred from water, designated as (w) to a nonpolar solvent (np), the free energy change (ΔG) of transfer is 6.12 kcal mol⁻¹ for the (A+D) mixture. A and D form a

hydrogen bond in this nonpolar solvent and ΔG for this process is $-2.4 \text{ kcal mol}^{-1}$. When the hydrogen bonded molecule A-D is transferred from water to the nonpolar solvent ΔG for this process is $0.62 \text{ kcal mol}^{-1}$. The value of ΔG for the formation of hydrogen bond ($A+B \leftrightarrow A-B$) in water is

1. $-0.1 \text{ kcal mol}^{-1}$.
2. $+3.1 \text{ kcal mol}^{-1}$.
3. $-3.1 \text{ kcal mol}^{-1}$.
4. $-1.78 \text{ kcal mol}^{-1}$.

74. In a human cell, the concentration of ATP, ADP and P_i are 2.25, 0.50 and 0.825mM respectively. The free energy of hydrolysis of ATP at pH 7.0 and 25°C is

1. -30.5 kJ/mol .
2. -61 kJ/mol .
3. -15.25 kJ/mol .
4. -52 kJ/mol .

75. Which one of the following enzyme reaction represents noncompetitive initiation?

1. $E+S \rightleftharpoons ES + E + P$
 $ES + I \xrightleftharpoons{K_i} EI$
2. $E+S \rightleftharpoons E+S \rightarrow E + P$
 $ES + I \xrightleftharpoons{K_i} ESI$
3. $E+S_1 \rightleftharpoons ES_1 \rightleftharpoons E'P_1 \xrightleftharpoons{P_1} E' \xrightleftharpoons{S_2} E'S_2 \rightarrow E+P_2$
4. $E+S \rightleftharpoons ES \rightarrow E+P$
 $E+S+I \xrightleftharpoons{K_i} EI + S$
 $ES + I \xrightleftharpoons{K'_i} ESI$
 $EI + S \rightleftharpoons ESI$

76. The sequence of monosaccharides including position and configuration of glycosidic bonds in a glycoprotein is to be determined. Which one of the following methods can be employed?

1. Glycoprotein \rightarrow removal of oligosaccharides by alkaline hydrolysis \rightarrow nuclear magnetic resonance analysis of cleaved mixture of oligosaccharides
2. Two dimensional nuclear magnetic resonance spectroscopic analysis of the glycoprotein
3. Glycoprotein \rightarrow release of oligosaccharides with endoglycosidases followed by purification to separate oligosaccharides \rightarrow enzymatic

hydrolysis of purified oligosaccharides with specific glycosidases → mass spectroscopic analysis of smaller oligosaccharides

4. Glycoprotein → treat with trypsin followed by MALDI analyses of tryptic peptides

77. A bacterial culture undergoing balanced growth requires a first-order reaction. In other words, the rate of increase in bacteria at any particular time is proportional to the number or mass of bacteria present at that time. If 'N' is the number of cells at any given time 't' and 'μ' is 'growth rate constant' this process can be expressed mathematically as

1. $\frac{dN}{dt} = \mu N$.

2. $\frac{dt}{dN} = \mu N$.

3. $\frac{d\mu}{dt} = N$.

4. $\frac{dN}{dt} \times N = \mu$.

78. A typical animal cell (nucleated) membrane contains glycolipids and glycoproteins in the plasma membrane. To determine its topological distribution, 'lectin' is used as a probe. The following interactions may be the basis of the probing method:

- (A) Protein-protein interaction
- (B) Protein-sugar interaction
- (C) Protein-lipid interaction
- (D) Protein-sterol interaction.

The appropriate answer is

1. Only (A).
2. Only (B).
3. All of (A), (B) and (C).
4. Only (D).

79. Upon studying a considerable number of different crosses in *Drosophila*, Morgan reached the conclusion that all genes of this fly were clustered into four linked groups corresponding to the four pairs of chromosomes. Further studies revealed that linkage is not absolute and it is broken frequently. It is broken in prophase by a process called

1. Recombination.
2. Jumping of genes.
3. Integration.
4. Mutation.

80. A population of proliferating cells is stained with a DNA binding fluorescence dye so that the amount of fluorescence is directly proportional to the quantity of DNA. Amount of DNA in each cell is measured by flow cytometry. The number of cells with a given DNA content is plotted and following statements were made:

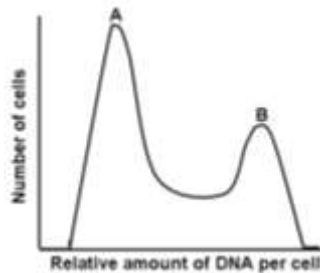

- (1) Peak A contains the cells of G_1 phase
- (2) Peak B contains the cells of G_2 phase
- (3) Peak A contains the cells of G_2 phase
- (4) Peak B contains the cells of G_1 phase

Which of the above mentioned statement is correct?

1. (1) and (2).
 2. (3) and (4).
 3. (2) and (4).
 4. (1) and (3)
81. During many important cell processes, many proteins need to undergo degradation to culminate a part of the process. For example, during cell cycle, cycling proteins need to be degraded to allow the cells to exit mitosis. This is achieved by selective ubiquitination of cyclin followed by its degradation by proteasomes. The specific protein factor that is involved in this process is called Anaphase Promoting Complex (APC). APC is possibly a protein which is known as
1. E1 enzyme.
 2. E₂ enzyme.
 3. E₃ enzyme.
 4. Protease.
82. During mitogenic stimulation, cells proliferate at a higher rate and it is primarily determined by an enhanced rate of protein synthesis. Among other mechanisms, MAP kinase pathway of signal transduction is involved in this. Global protein synthesis may be regulated by many mechanisms involving various steps of protein synthesis, namely, initiation, elongation and termination. Thus, many protein factors may be involved in the same. In the above process (mitogenic stimulation) the following factors are the portable targets.

- A. eIF -2
- B. eEF-1
- C. S6 kinase
- D. eIF-4E BP

The correct answer is

- 1. A+B
- 2. C+D
- 3. D+A
- 4. B+D

83. DNA repair, synthesis and recombination are intimately connected and inter dependent. An apparent commonality between processes of DNA replication and repair in the enzymatically catalyzed synthesis of DNA polynucleotide segments, which can be assembled with preexisting polynucleotides, leading to repair or replication. Synthesis of these polynucleotide segments is catalyzed by a group of enzymes DNA-dependant DNA polymerases. In the case of *E.coli*, DNA polymerase has been isolated in three distinct forms whereas five main types of polymerase have been isolated from mammalian cells. All the polymerases synthesize polynucleotides only in the 5' → 3' direction. If polynucleotide chains could be elongated in 3' → 5' direction, the hypothetical growing 5' terminus, rather than the incoming nucleotide, would carry a triposphate that is unsuitable for further elongation. The 3' → 5' exonuclease activity is not associated with all the polymerases and only present in

- (A) All *E. coli* DNA polymerases but not all mammalian polymerases.
- (B) Pol I, Pol II, Pol III, Pol α, Pol β.
- (C) Pol I, Pol II, Pol δ, Pol ε, Pol γ
- (D) Pol I, Pol II, Polα, Pol ε.

The correct statements are

- 1. (A) and (B).
- 2. (A), (B) and (C).
- 3. (A) and (C).
- 4. (A), (C) and (D).

84. Bacteriophage λ genetic circuit may be represented as follows:

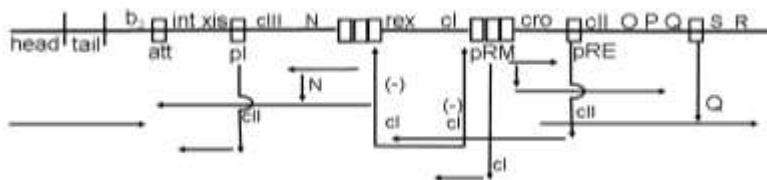

The control of gene expression occurred during the phage infection may be described as follows:

- (A) N and Q protein act as antiterminator
- (B) CI acts only as repressor
- (C) CII act as a retroregulator
- (D) CI and CII both act as positive and negative regulator

Which one of the statements are correct?

- 1. (A), (B) and (C).
- 2. (B), (C) and (D).
- 3. (A) and (D) only.
- 4. (A), (C) and (D).

- 85.** Rho factor is involved in termination of transcription in prokaryotes. Genetic manipulations indicate that Rho-dependent termination requires the presence of a specific recognition sequence on the newly synthesized RNA upstream of the termination site. The recognition sequence must be on the nascent RNA rather than the DNA, as demonstrated by Rho's inability to terminate transcription in the presence of pancreatic RNase. The essential features of this termination site have not been fully elucidated. Construction of synthetic termination sites indicates that it consists of 80 to 100 nts that lack a stable secondary structure and contain multiple regions that are rich in C and poor in G.

Which of the following is/ are suggested by the above observation?

- 1. Rho factor attaches to nascent RNA at its recognition sequence and then migrates along the RNA in the 5'→3' direction until it encounters an RNAP paused at the termination site.
- 2. Rho unwinds the RNA-DNA duplex forming the transcription bubble, thereby releasing the RNA transcript.
- 3. Rho factor attaches to the RNA at its recognition sequence while RNA is in the RNA-DNA hybrid condition.
- 4. There may be other factors and hence Rho factor does not need to unwind the RNA-DNA hybrid to release the transcript.

- 86.** During development and differentiation, there is a dynamic programme of differential expression of sets of genes. In bacteria, phage infections are among the simplest examples of developmental process. Typically, only a subset of the phage genome, offer referred to as immediate early genes, are expressed in the host immediately after phage infection. As time passes, early genes start to be expressed, and the immediate early genes and bacterial genes are turned off. In the final stage of phage infection, the early genes give way to late genes. One of the simplest way it is achieved is through

- (A) expression of cascade of σ factors
- (B) expression of new RNA polymerases
- (C) expression of different holoenzymes
- (D) expression of different transcription factors

The correct reasons are

1. (A), (D)
2. (A), (C), (D)
3. (A), (B), (D)
4. (A), (B), (C)

87. Polyclonal antibodies are raised against bovine serum albumin in rabbit. Subsequently IgG in the antiserum is purified and digested with either pepsin or papain. Out of the following possibilities, which one is correct?

1. Pepsin-digested antibodies cannot precipitate the antigen
2. Papain-digested antibodies cannot precipitate the antigen
3. Pepsin digestion will produce two Fab molecules
4. Pepsin-digested antibodies will lose all interchain disulfide bonds

88. Two protein kinases, K_1 and K_2 function sequentially in regulating intracellular pathway in response to extracellular signal. The following observations are made:

- (i) Response is observed even in the absence of extracellular signal when a mutation permanently activates K_1 .
- (ii) Response is observed even in the absence of extracellular signal when K_1 contains an activating mutation and K_2 with inactivating mutation.
- (iii) No response in the cells is detected even in the presence of extracellular signal when both kinases are inactivated by mutation.

Which one of the following is correct?

1. K_1 activates K_2
2. K_2 activates K_1
3. K_1 inhibits K_2
4. K_2 inhibits K_1

89. Conversion of proto-oncogene to oncogene may involve the following processes:

- A mutation in coding sequence
- B gene amplification
- C chromosome rearrangement
- D mutation in non-coding sequence

Which one is appropriate?

1. A, B and C
2. B, C and D
3. A, C and D
4. All

- 90.** Opsonisation of a bacterium is a process by which specific antibody binds with the surface molecule of the bacteria. In an experimental condition, macrophage were infected with either WT: Mycobacteria or with opsonised: Mycobacteria for 2 hrs at 37°C. Subsequently, cells were washed and further incubated for 24 hrs at 37°C. Finally, bacterial load in macrophages were determined by colony forming unit (CFU). Which of the following observation is true?
1. WT: Mycobacteria inhibits its transport to the lysosomes and survive in macrophages.
 2. Opsonised: Mycobacteria inhibits its transport to the lysosomes and survive in macrophages.
 3. WT: Mycobacteria are targeted to the lysosomes and killed in macrophages.
 4. Opsonised: Mycobacteria are targeted to the lysosomes and survive in macrophages.
- 91.** Which of the following cannot be used for determination of tissue lineage of a given progenitor cell population in an animal?
1. Marking progenitor cells with vital dye.
 2. Transplanting equivalent progenitor cells from immunologically distinct but related organism.
 3. Marking progenitor cells by genomic recombination coupled with reporter gene expression.
 4. Marking progenitor cells by reporter gene expression under the control of a promoter – enhancer element specific for the given progenitor population.
- 92.** During vertebrate limb development, a specialised ectodermal structure, called Apical Ectodermal Ridge (AER), forms at the dorso-ventral ectodermal boundary at the distal tip of the developing limb bud.
The following experimental facts about the AER is available:
- (A) FGF 2, 4, and 8 are expressed in the AER
 (B) Removal of the AER causes cessation of limb growth
 (C) Removal of AER along with implantation of beads soaked in FGF 8 or
 (D) FGF 4 or FGF 2 protein rescues the AER removal phenotype and gives rise to normal limb
- Which of the following statements cannot be made based on the above facts?
1. FGF 2, 4, and 8 are secreted proteins.
 2. FGF 2, 4, and 8 are necessary and sufficient for AER function
 3. FGF 2, 4, and 8 are sufficient for AER function
 4. FGF 2, 4, and 8 have largely redundant functions
- 93.** During fertilization in amphibians, the fusion of egg and sperm plasma is preceded by

- (A) release of enzymatic contents from the acrosomal vesicle through exocytosis
- (B) binding and interaction of the sperm to vitelline membrane
- (C) chemoattraction of the sperm to the egg by soluble factors secreted by egg
- (D) passage of sperm through extracellular envelope

Which of the following is the correct sequence?

- 1. (A) → (B) → (C) → (D)
- 2. (B) → (A) → (C) → (D)
- 3. (C) → (A) → (B) → (D)
- 4. (C) → (B) → (A) → (D)

94. In many different contexts of cell differentiation, two distinct cell populations emerge from a uniform cell population. This process is referred to as lateral inhibition. Which one of the following must not be true about lateral inhibition?

- (A) lateral inhibition results from morphogen action
- (B) lateral inhibition requires direct cell cell contacts
- (C) lateral inhibition requires reciprocal signalling between two neighbouring cells
- (D) lateral inhibition is preceded by stochastic changes in gene expression in two neighbouring cells

- 1. (D)
- 2. (A) and (D)
- 3. (B) and (C)
- 4. (A)

95. Which of the following statements is true about dorso-ventral patterning of drosophila embryo?

- (A) This is dictated by the location of the nurse cells
- (B) dorsal is the default fate
- (C) The whole process is regulated by preventing the entry of a transcription factor to the nucleus of dorsal cells
- (D) Homeobox containing genes play a critical role in this process.

- 1. (A), (B) and (C)
- 2. (A),(B), (C) and (D)
- 3. (A) and (D)
- 4. (B) and (C)

96. Which of the following is true about amphibian limb regeneration?

- (A) It requires a minimum number of functional nerves.
- (B) The blastema of an amputated limb, if transplanted in the trunk region between two existing limbs in a host, will still give rise to a limb.

- (C) The size of the regenerated limb is often grossly different from the original limb.
1. (A)
 2. (B) and (C)
 3. (A) and (C)
 4. (A), (B) and (C)
- 97.** In agamous mutant (flower within flower phenotype) which of the following statements is valid?
1. Class A genes are expressed in the first two whorls, Class B genes are expressed in the second and third whorls and Class C genes are expressed in the third and fourth whorls.
 2. Class A genes are **not** expressed. Class B and C genes are expressed in all the whorls.
 3. Class A genes are **not** expressed. Class B genes are expressed in the second and the third whorls and Class C genes are expressed in all the whorls.
 4. Class A genes are expressed in all the whorls. Class B genes are expressed in the second and the third whorls.
- 98.** Plants grown in greenhouse at 25°C when exposed first to 35°C for 6 hours and subsequently to 42°C for 12 hours adapt better to the high temperature (42°C) in comparison to those directly transferred to 42°C for the same duration. What is the phenomenon called and what is its main physiological basis?
1. Acquired thermo-tolerance because of the induction of mutagens resulting into improved stability of all the proteins.
 2. Induced thermo-tolerance because of the induction of heat shock proteins.
 3. Induced thermo-tolerance because changes in RNA polymerase II resulting in efficient and improved transcription.
 4. Acquired thermo-tolerance because of efficient post translational modification of proteins.
- 99.** In which molecule would the radiolabel appear the earliest when wheat and sugar cane leaves are fed with $^{14}\text{CO}_2$?
1. Wheat – malate, sugarcane – 3phosphoglycerate.
 2. Wheat – aspartate, sugarcane – malate.
 3. Wheat – 3phosphoglycerate, sugarcane – 3phosphoglycerate.
 4. Wheat – 3phosphoglycerate, sugarcane – malate.
- 100.** A young dicot seedling (e.g soyabean) is subjected to gravity stimulus by laying it horizontally on a surface the shoot bends upwards and root bends downward. Indicate the reason.

1. Redistribution of auxin throughout the seedlings is responsible for stimulatory unequal growth in shoots and roots.
2. Redistribution of auxin in shoots while cytokinin in roots is responsible for stimulatory unequal growth.
3. Redistribution of auxin in roots while cytokinin in shoots is responsible for stimulatory unequal growth.
4. Redistribution of cytokinin throughout the seedlings is responsible for stimulatory unequal growth in shoots and roots.

101. Which of the following statements are associated with the process of photorespiration in plants?

- (A) Photorespiration takes place in only C3 plants.
- (B) Photorespiration takes place in only C4 plants.
- (C) Photorespiration takes place in both C3 and C4 plants.
- (D) Glycolate is oxidized to glyoxylate in the peroxisome.
- (E) Glycolate is oxidized to glyoxylate in the mitochondria.

1. (A) and (D)
2. (C) and (D)
3. (B) and (E)
4. (C) and (E)

102. Aspartate kinase is a key enzyme in the lysine amino-acid biosynthesis in plants. With an objective of increasing the lysine content in maize seeds, maize plants were transformed with *E.coli* aspartate kinase with a strong seed specific plant promoter. Resulting transgenic plants were found to express the transgene; however, the content of lysine did not increase. Which of the following option best explain the possible reason?

1. Bacterial proteins are not stable in plants.
2. Bacterial proteins are not properly folded in plants.
3. Proper post-translational modification did not take place in plants.
4. Lysine causes feed back inhibition of aspartate kinase

103. Electrical stimulation of a nerve bundle maintained at $37 \pm 1^{\circ}\text{C}$ showed A, B, C and D peaks (as shown in the diagram) when recorded at a distance of 15 cms from the stimulating site on the same bundle. The same experiment was conducted at significantly lower temperature $15 \pm 1^{\circ}\text{C}$. Which of the following statements is correct?

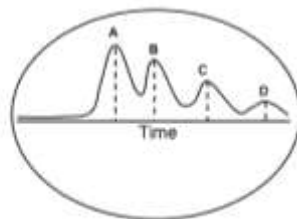

Lower temperature would

1. not affect the record.
2. not show A, but would show B, C and D peaks.
3. not show peak D and may not show C, but would show A and B.
4. show all the peaks along with a new peak

- 104.** A response was observed when a specific site in a rat brain was stimulated by passing electrical pulses through indwelling electrode implanted surgically. In another experiment in another rat, a cannula was surgically implanted instead of the electrode and stimulated the area by injecting excitatory neurotransmitter. However, the result of the two experiments did not match. The possibilities of variations in the results could be due to
1. animal variations only.
 2. stimulation of cell bodies or nerve fibers only.
 3. difference in anatomical brain areas only.
 4. variations in all the reasons mentioned in 1, 2 and 3.

- 105.** (A) In an experiment, 2mg of a substance 'A' dissolved in 4.5 ml sterile solvent was injected as a bolus into the femoral vein of an intact frog. It was observed that the frog's heart rate increased significantly.
- (B) The same solution as in (a) when applied directly on the heart of the same frog after exposing the heart, the heart rate did not change.
- (C) The same solution as in (a) when injected to an intact cat femoral vein, the heart rate did not change significantly.

From the above observations, which one of the following statements is most likely to be correct?

1. Substance 'A' is stimulatory on heart and the effect was inotropic.
2. substance 'A' acted in the brain and also might have released other hormones to increase the heart rate.
3. substance 'A' could not have acted on the brain but must have induced other substances in the blood to increase the heart rate.
4. the increased heart rate was merely due to increased volume of the heart muscles.

- 106.** In a healthy kidney given the following information:

- (A) Glomerular hydrostatic pressure – 75 mm Hg
(B) Glomerular capillary colloid osmotic pressure – 40 mm Hg
(C) Hydrostatic pressure in the Bowman's capsule – 20mm Hg

The net filtration pressure will be

1. 55mn Hg.
2. 15 mn Hg.

3. 35 mn Hg.
4. 135 mn Hg.

107. Identical limb lead electrocardiograms from three adult subjects taken by the same machine under identical conditions are shown in the figure. The X-Y scales should be considered identical for all three electrocardiograms. Which of the following statements is correct?

1. (a) and (c) are from normal individuals having normal hearts, while (b) shows abnormal atrial repolarization.
2. (a) is normal, (b) ventricular defect while (c) abnormal propagation of electrical waves through atrium only.
3. (a) is normal, (b) atrial depolarization is opposite to that of in a normal heart and (c) shows local damage throughout the ventricle possibly due to previous myocardial infarction.
4. (a) and (c) are from normal individuals, having normal heart, where as (b) is from an individual with abnormal propagation of electrical waves through the ventricle only.

108. Mismatch of blood in parents may result in erythroblastosis fetalis in a new born. Match the correct cause (left column) and usual treatment (right column).

Commonest cause	Used treatment
A. Mother Rh(+) and father Rh(-)	C. replacement of neonate's blood with Rh(-) blood.
B. Mother Rh (-) and father Rh (+)	D. replacement of neonate's blood with Rh(+) blood.

1. A and C
2. A and D
3. B and C
4. B and D

109. In a haploid organism, the loci A/a and D/d are 8 map units apart. In a cross Ad X aD, what will be the proportion of each of the following progeny classes: (a) Ad (b) Recombinants.

1. 92%, 8%
2. 46%, 8%
3. 92%, 4%
4. 46%, 4%

110. During an experiment, an investigator found that the cell line used are RecA^{-/-}. What could be the probable finding which led him to such observation?

1. Loss of recombination.
2. Showing aberrant all morphology.

3. Cells developed phagocytic properly.
4. Cells were aggregating.

111.

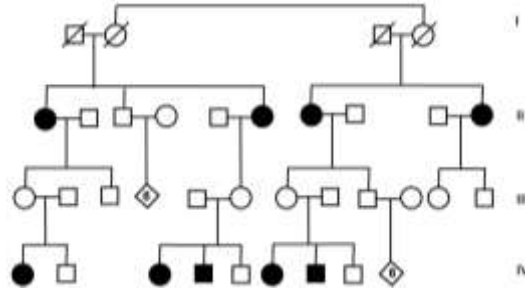

Find the pattern of inheritance of the trait showing incomplete penetrance from the figure shown above.

1. Autosomal dominant.
2. Autosomal recessive.
3. Mitochondrial inheritance.
4. X-linked recessive.

112. Which of the following assumption support the Hardy-Weinberg Equilibrium?

1. Presence of Natural Selection.
2. Random mating.
3. Genetic Drift.
4. Assortative mating.

113. Which of the following illustrations explain the correct pairing preceding recombination between a chromosome (ABC•DEFG/ABC•DEFG) and its inverted homologue (ABC•DGFE/ABC•DGFE). The dot in genotype represent the centromere.

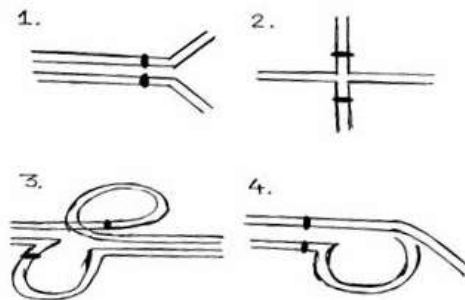

114. In *E. coli* , four Hfr strains donate the genetic markers shown in the order shown:

Strain 1:	F	L	K	O	Z
Strain 2:	C	Y	A	Z	O
Strain 3:	P	D	W	C	Y
Strain 4:	P	F	L	K	O

All the Hfr strains are derived from the same F^+ strain. What is the order of these markers on the circular chromosome of the original *E.coli* F^+ strain?

1. K O Z P D F L W C Y A K
 2. F L K O Z P D W C Y A F
 3. F L K O Z A Y C W D P F
 4. F L K C Y A Z O W D P F
- 115.** In a family, father is homozygous dominant (AA) for a gene A and his wife is homozygous for its recessive allele (aa) showing albino phenotype. It was surprising that their child showed the albino phenotype. Which of the following phenomenon can explain the phenotype?
1. Nondisjunction
 2. Uniparental Disomy
 3. Gene conversion
 4. All of the above
- 116.** Which of the following characteristic differentiate Eubacteria from Archaeobacteria?
1. Circular nature of chromosome.
 2. Absence of nuclear membrane.
 3. Presence of 70S ribosomes.
 4. Presence of murein in cell wall.
- 117.** Tropical semievergreen forests are found in the region having rainfall
1. > 3000 mm.
 2. 2000 – 2500 mm.
 3. 1200–2500 mm.
 4. 800–1200 mm.
- 118.** Presence of which of the following flora and fauna in Peninsular India is explained by the Satpura hypothesis?
1. Chinese.
 2. Malayan.
 3. African.
 4. Mediterranean.

119. Complete the following sentence using options given below the sentence as a, b, c, d and e.

“Species are critically endangered when it is not endangered but is facing _____ risk of extinction in the wild in the _____ future”.

- (a) high
- (b) very high
- (c) extremely high
- (d) near
- (e) immediate

- 1. a, a
- 2. b, c
- 3. c, e
- 4. c, d

120. Based on Coefficient of Association table given below, which of the following taxonomic phenogram of relationship is correct?

	S	T	W	X	Y	Z
S	1.0					
T	0.8	1.0				
W	0.5	0.7	1.0			
X	0.6	0.6	0.9	1.0		
Y	0.3	0.1	0.2	0.2	1.0	
Z	0.2	0.0	0.3	0.4	0.9	1.0

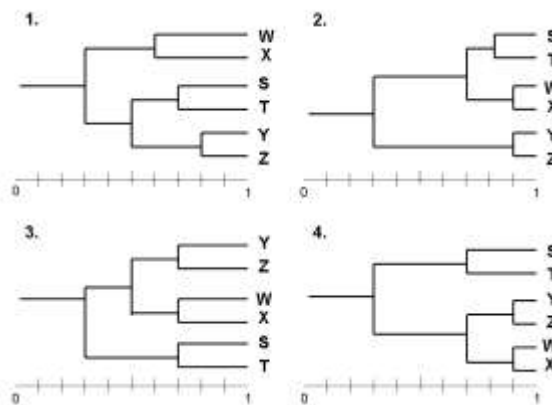

121. Which one of the following trait set characterizes best a r selected species?

- 1. Usually a type III survivorship curve, short life span and density dependent mortality
- 2. Usually a type I survivorship curve, short life span and density dependent mortality

3. Usually a type I survivorship curve, long life span and density independent mortality
4. Usually a type III survivorship curve, short life span and density independent mortality

122. The following graphs show the population growth of two species P and Q, each growing either alone (a) or in the presence of other species (b).

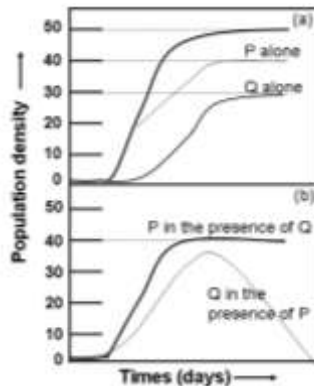

The most important conclusion to be drawn from the graph is

1. P and Q are equally competitive.
 2. In competition, the growth of both species is adversely affected.
 3. In competition, species P remains unaffected while Q suffers.
 4. There is no evidence of competitive exclusion.
123. Three important biological parameters – generation time, population growth rate (r) and metabolic rate per gram body weight are a function of the organism's body size. Which of the curves (a) or (b) represents the correct relation of each of the parameters to body size?

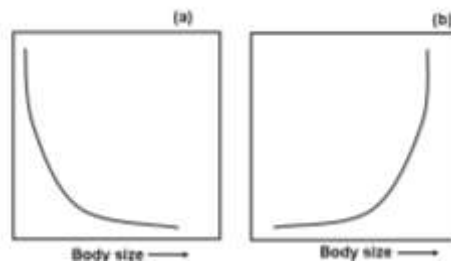

1. Generation time – (a); population growth rate – (b); metabolic rate/g bw – (a)
2. Generation time – (a); population growth rate – (b); metabolic rate/g bw – (b)
3. Generation time – (b); population growth rate – (a); metabolic rate/g bw – (a)
4. Generation time – (b); population growth rate – (b), metabolic rate rate/g bw – (a)

124. Nearly 25% of all insect species are known to be herbivores. Yet, in spite of such heavy herbivore pressure, globally green plants tend to persist, contributing to a 'green earth'. Which of the following account for the relative success of green plants?

- (A) Herbivore insects are inefficient feeders
- (B) Herbivore insect densities are kept low by predators
- (C) Plants secrete herbivore-deterrent chemicals

- 1. (B) and (C)
- 2. (A) only
- 3. (B) and (C)
- 4. (A), (B) and (C)

125. In the process of nitrification by organisms, the respective bacteria A and B in the following reaction are:

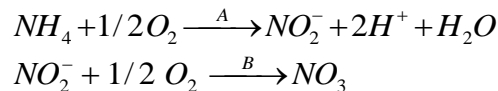

- 1. *Azotobacter, Nitrobacter*
- 2. *Nitrobacter, Azotobacter*
- 3. *Nitrosomonas, Nitrobacter*
- 4. *Nitrobacter, Nitrosomonas*

126. The flightless birds ostrich, rhea and emu are distributed on different continents. What is the most plausible explanation that is given by an evolutionary biologist for this discontinuous observation?

- 1. The birds were able to fly earlier, but lost their flight ability later
- 2. Prehistoric humans transported these birds to different continents
- 3. The birds, although flightless, may have used drifting logs to cross the ocean and reach other continents
- 4. All the continents used to be one single supercontinent earlier and the flightless birds were isolated after the break up of the landmass.

127. In spite of its two-fold cost, sexual reproduction is the most dominant mode of reproduction among the living organisms. Which of the following reasons might account for this?

- (A) Sexual reproduction generates genetic heterogeneity through recombination
- (B) Sexual reproduction helps in purging deleterious mutations
- (C) Sexual reproduction evolved to stay evolutionarily ahead of fast evolving internal parasites.

- 1. (A) only
- 2. (A) and (B)
- 3. (C) only
- 4. (A), (B) and (C)

- 128.** A moth species occurs as two distinct morphs based on wing colour – pale and dark. In the forest there are trees with dark coloured trunks as well as those with light coloured trunks and the moths can rest on either tree. Birds capture the resting moths and eat. In a field experiment, the proportion (%) of dark and pale morphs captured from dark and light trunk trees was recorded.

Tree Trunk Colour	Moth morph	
	Dark	Pale
Dark	45	55
Light	48	52

The most plausible conclusion to be drawn from the results is

1. Natural selection favours dark morphs in forests where trees with dark trunks are dominant.
 2. Birds can detect dark morphs better than light morphs.
 3. Pale morphs prefer to rest on light coloured trunks
 4. Birds detect the moths by cues other than their wing colour.
- 129.** It is found that people with the genetic disease called sickle cell anaemia are resistant to malaria. Which of the following best describes the underlying mechanism?
1. Frequency-dependent selection
 2. Superiority of heterozygotes
 3. Transient polymorphism
 4. Balanced polymorphism
- 130.** In a bird species A, the male alone builds the nest, incubates the eggs and feeds the nestling. In bird species B, it is the female that does all that. In bird species C, both sexes contribute equally to the above activities. In species A and B, the uninvolved partner may fly away and mate again. Which sex among A, B and C is most likely to develop colourful plumage during breeding season?
1. Male in species A and B, both sexes in species C.
 2. Female in species A, male in species B and C.
 3. Female in species A and B, neither in species C.
 4. Female in species A, male in species B, neither in species C.
- 131.** If a given gene in a randomly mating population has three alleles a, b and c in the ratio of 0.5, 0.2 and 0.3 respectively, what is the expected frequency of genotypes ab and bc in the population at equilibrium?
1. 0.1 and 0.06
 2. 0.2 and 0.15
 3. 0.2 and 0.12
 4. 0.04 and 0.09

132. The following table lists some of the enzymes of fungi and bacteria having wide variety of industrial applications, including alcoholic beverages, food, detergents and pharmaceuticals, along with their microbial original

Enzyme	Microorganism
A. Amylase	E. <i>Azotobacter vinelandii</i>
B. Asparaginase	F. <i>Serratia marcescens</i>
C. Lipase	G. <i>Aspergillus aureus</i>
D. Pectinase	H. <i>Aspergillus oryzae</i>

The correct combinations are

1. A and H
 2. B and G
 3. C and E
 4. D and F
133. Animal cell cultures are frequently used for production of therapeutic proteins. NIH3T3 (a fibroblast cell line) and CHO (Chinese hamster ovarian cell line) are some of the popular cell lines used. Choose the best combination of cell line (for transfection) and starting material for purification of human growth hormone, a secretory protein
1. NIH3T3 cell pellet
 2. CHO and cell pellet
 3. NIH3T3 and culture medium
 4. CHO and culture medium
134. A novel vaccine (against malaria liver stage specific) has been developed by an investigator. This happened to be the parasites unique cell surface protein molecule (M_p). This M_p when injected in mice elicits humoral antibody response (I_gG in nature) and can efficiently neutralize sporozoites by inhibiting their binding to the liver cells. Upon a pre-clinical trial this vaccine failed universally despite a high titre I_gG response. Which one out of the choices below is the correct answer of this failure?
1. The liver cell surface receptor to which M_p binds is changed.
 2. The malaria parasite is successful in changing the epitope in M_p to which I_gG binds
 3. I_gG molecules change its binding sites for M_p .
 4. The affinity of I_g to M_p epitopes is reduced.
135. Following are some statements about *Agrobacterium* – plant interactions
- (A) *Agrobacterium* transfers a part of its chromosome into plant cell.
 - (B) *Agrobacterium* transfers a part of one of its plasmid DNA into plant cell.
 - (C) All the virulence genes of *Agrobacterium* are inducible.

- (D) All the virulence genes of *Agrobacterium* are functional only inside the bacterial cells.
- (E) Some of the virulence genes of *Agrobacterium* are inducible.
- (F) Some of the virulence genes of *Agrobacterium* are functional both in bacterial and plant cells.

Which of the following combination of statements is true?

- 1. (A), (C) and (D)
- 2. (B), (E) and (F)
- 3. (C), (D) and (E)
- 4. (B), (E) and (F)

- 136.** To generate a knock-in or a knock-out mouse, it is essential to use antibiotic selection to select the stem cells that have putatively integrated the construct accurately. Each construct will have 5' homology arm and 3' homology arm to help in homologous recombination. A positive antibiotic selection cassette and a negative antibiotic selection cassette are also used. Negative selection cassette helps in de-selection of non-homologous recombinant stem cells.

Choose one statement indicated below that reflects the correct position of the negative selection cassette.

- 1. Negative selection cassette is supplied in a separate construct.
- 2. Negative selection cassette is placed between the two homology arms.
- 3. Negative selection cassette is placed 3' to the 3'-homology arm.
- 4. Negative selection cassette is inserted between the promoter Exon I of positive selection cassette.

- 137.** Following are the different ways of obtaining human stem cells-

- (A) Cells from morula are dispersed and cultured to give rise pluripotent stem cells.
- (B) Isolated inner cell mass of a blastocyst are cultured and they become pluripotent stem cells.
- (C) The primordial germ cells from a fetus are collected and cultured, which grow into pluripotent stem cells.
- (D) Stem cells are collected from adult tissues and grown in specific manner to develop into pluripotent stem cells.

Which of the above cell type(s) is extensively used for somatic cell gene therapy in human?

- 1. (A) and (B)
- 2. (B) only
- 3. (B) and (D)
- 4. (D) only

- 138.** RFLP and RAPD markers are commonly used in plant breeding and diversity analysis. Which of the following combination of statement about these molecular makers are correct?
- A. RFLP is co dominant
 - B. RAPD is co dominant
 - C. Both the markers are ubiquitous
 - D. Only RFLP can detect heterozygote
 - E. Only RAPD can detect heterozygote
 - F. RAPD cannot detect allelic variation
- 1. A, C, D, E
 - 2. B, C,E,F
 - 3. A,C,D,F
 - 4 C,D,E,F
- 139.** Which one of the following indicate steps involved in DNA foot-printing to monitor interaction of DNA with a protein?
- 1. DNA + protein→treat with restriction enzymes → run agarose gel → stain with ethidium bromide and view under UV light.
 - 2. Label one of the DNA strands with a radiolabel→treat one portion of labelled DNA with the protein of interest followed by reaction with DNase→treat second portion of DNA with only DNase. Run both the treated DNA samples on a sequencing gel.
 - 3. Analyze fragments obtained from the experiments described in (2) by MALDI mass spectrometry.
 - 4. DNA + protein → treat with DNase followed by restriction enzymes. Run the sample on SDS page and visualize by commassie blue staining.
- 140.** A student is asked to isolate and purify various subcellular organelles from a liver cell sample. Following sucrose density gradient centrifugation technique, and taking utmost care mitochondrial fraction is found to be contaminated with nuclear fraction. Which technique out of the choices given below should be appropriate to obtain a clean mitochondrial fraction?
- 1. Gel filtration
 - 2. Percoll density gradient
 - 3. Immuno-magnetic separation
 - 4. Pulse field electrophoresis
- 141.** During receptor-mediated endocytosis, ligand first binds with cell surface receptor, then traffic through Rab5 positive early endosomal compartment. Finally, it moves to the Lamp1 positive lysosomes via Rab7 positive late compartment. In order to understand the trafficking of ligand A in epithelia cells, cells were allowed to internalize ligand A for various period of times at 37°C. Finally, cells were stained with anti-ligand antibody and

probed with secondary antibody labelled with Alexa-Red fluorescence dye. Same cells were also co-stained with anti-Rab5, anti-Rab 7 or anti-Lamp1 antibody and probed with appropriate secondary antibody labelled with Alexa-green fluorescence dyes. Cells were viewed in confocal microscope and observations are (I) 5 min internalize ligand (Red) in cells are colocalize with anti Rab5 antibody but not with anti-Lamp1 antibody and (II) 90 min internalized ligand are colocalized with anti-Lamp1 antibody but not with anti-Rab5 antibody. The following conclusions could be arrived at from the above observations.

- (A) Ligand A travels to early endosomal compartment by 5 min.
- (B) Ligand A travels to early endosomal compartment by about 90 min.
- (C) Ligand A travels to lysosome by about 5 min.
- (D) Ligand A travels to early endosome by about 90 min.

Identify the correct inferences.

- 1. (A) and (B)
- 2. (B) and (D)
- 3. (C) and (D)
- 4. (D) and (C)

- 142.** The values of molar absorption coefficient (ϵ) of Trp and Tyr at 240 nm and 280 nm are the following:

Wavelength (nm)	$E_{\text{Tyr}} (\text{M}^{-1} \text{cm}^{-1})$	$\epsilon_{\text{Trp}} (\text{M}^{-1} \text{cm}^{-1})$
240	11,300	1,960
280	1,500	5,380

A 10-mg sample of a protein is hydrolyzed to its constituent amino acids and diluted to 100 ml. The absorption of this solution in a 1-cm path length, is 0.717 at 240 nm and 0.239 at 280nm. The estimated content of Trp and Tyr in $\mu\text{mol} / \text{g}$ protein respectively are

- 1. 586 and 28.1.
- 2. 58.6 and 281.
- 3. 586 and 281.
- 4. 58.6 and 28.1.

- 143.** The structure of a protein is known from X-ray diffraction studies which gave 30% α -helix, 50% β -sheet and 20% random coil. Circular dichroism (CD) measurements gave 50% α -helix, 40% β -sheet and 10% random coil. What could not be a possible explanation for these observations.

- 1. Protein structure in the crystal is different from that in the solution.
- 2. CD analysis for structural components is not appropriate for this protein.
- 3. Contributions from other chromophores also contribute to the CD spectrum of the protein
- 4. Protein contains high content of disulphide bonds.

144. In column I are given equations and in column II what the equations represent. Column I and II are incorrectly matched.

I	II
1. $\frac{dN_1}{dt} = r_1 N_1 \left(\frac{K_1 - N_1}{K_1} \right)$	(a) Population growth of species 1 in the presence of competing species 2
2. $\frac{dN_1}{dt} = r_1 N_1$	(b) Logistic population growth of species 1
3. $\frac{dN_1}{dt} = r_1 N_1 \left(\frac{K_1 - N_1 - \alpha N_2}{K_1} \right)$	(c) Population growth of prey species 1 in the presence of predator species 2.
4. $\frac{dN_1}{dt} = N_1 b_1 - d_1 N_1 N_2$	(d) Exponential population growth of species 1.

The correct match in sequence of the four equations from column II is

1. b, d, a and c
 2. d, b, c and d
 3. b, d, c and a
 4. d, b, a and c
145. It is claimed that the mean (μ) arsenic concentration in the ground water of village is $20\mu\text{g/L}$ with $\sigma = 3$. In a random sample of 16 measurements what values of arsenic concentration should lead to rejection of the claim with 95% confidence?
1. values lower than 18.53 and values higher than 21.47
 2. values higher than 21.47
 3. values lower than 18.53
 4. values lower than 18.07 and values higher than 21.93